

Reading Scales

Write the temperature shown on each thermometer.

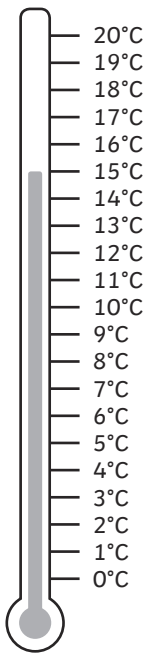

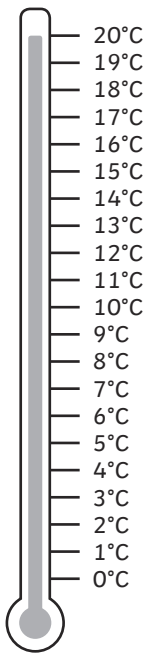

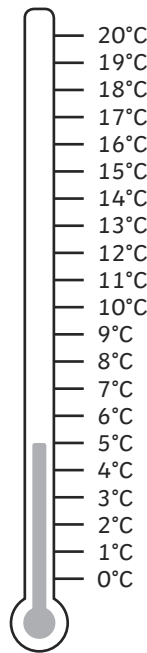

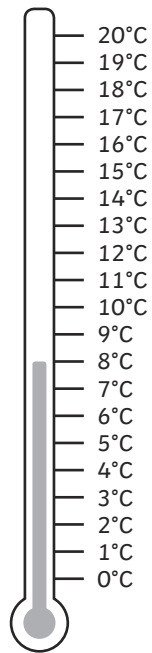

Write how much liquid is in each jug.

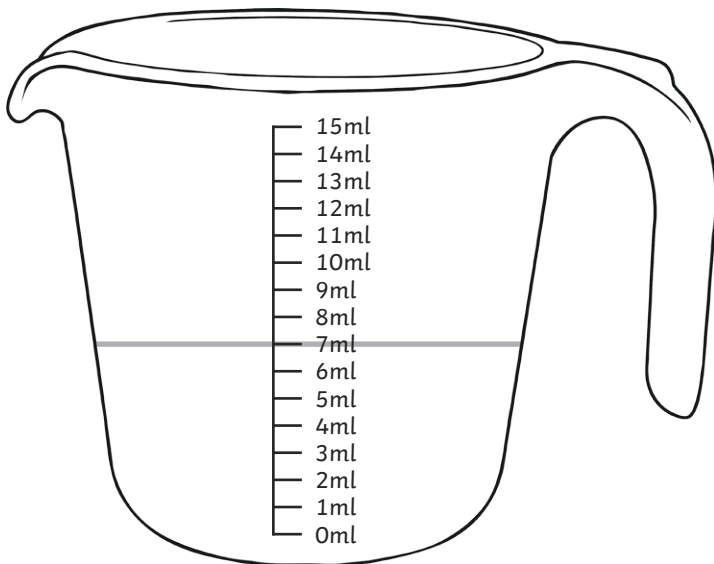

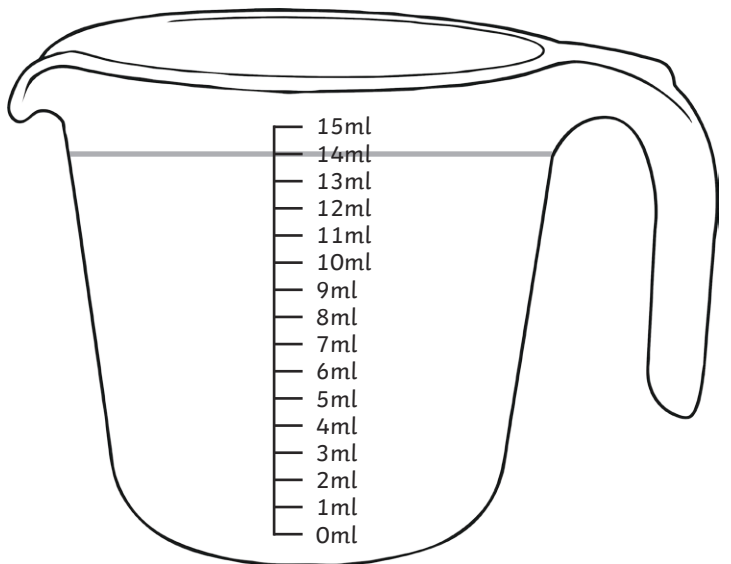

Reading Scales

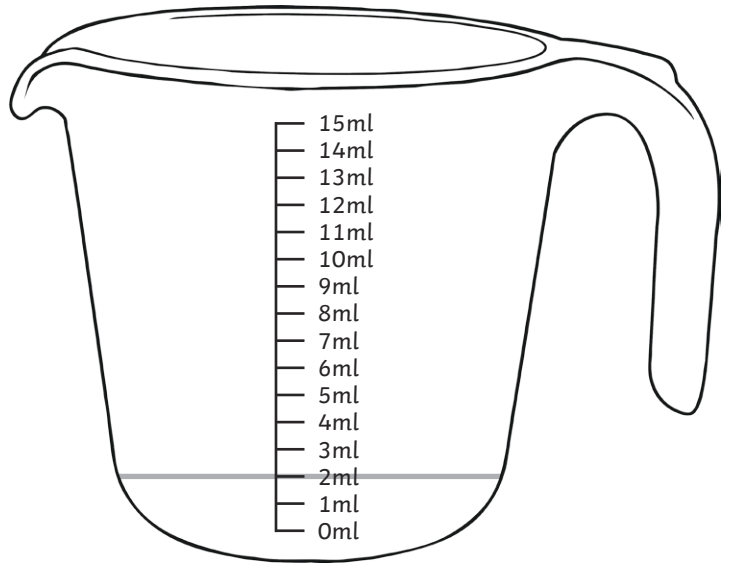
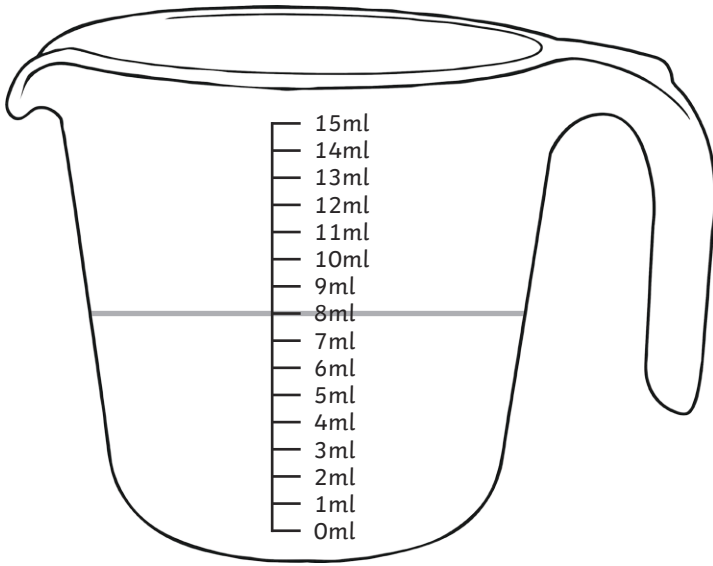

Write how much each parcel weighs.

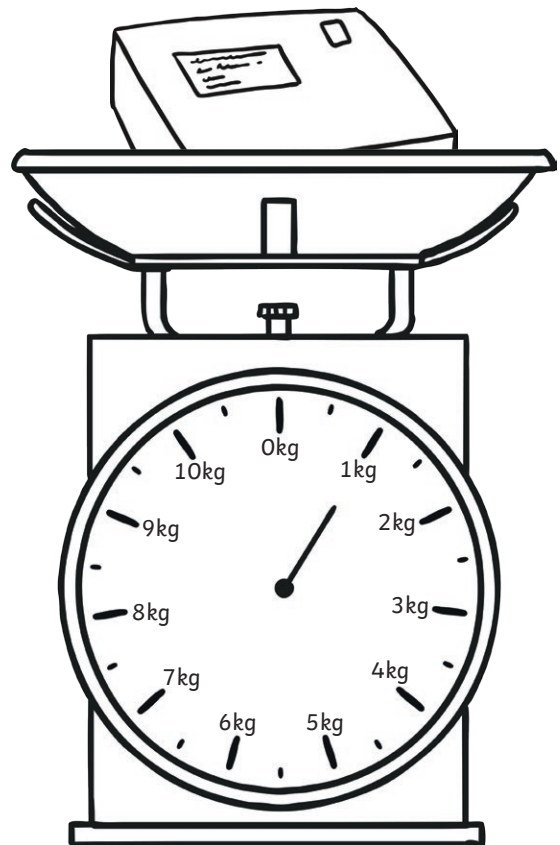
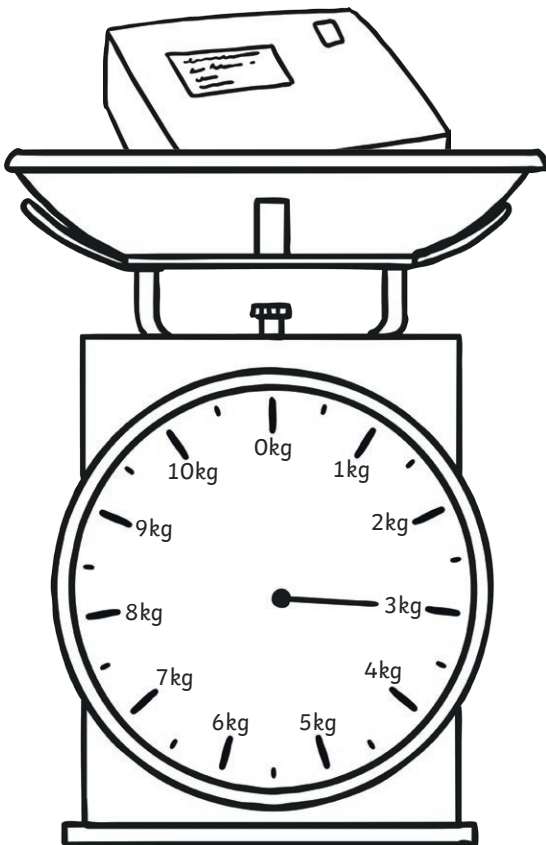

Reading Scales

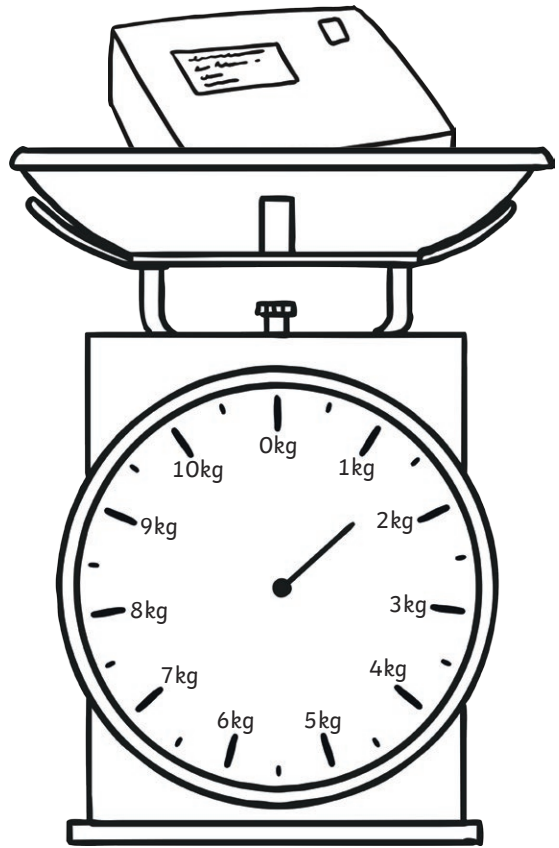
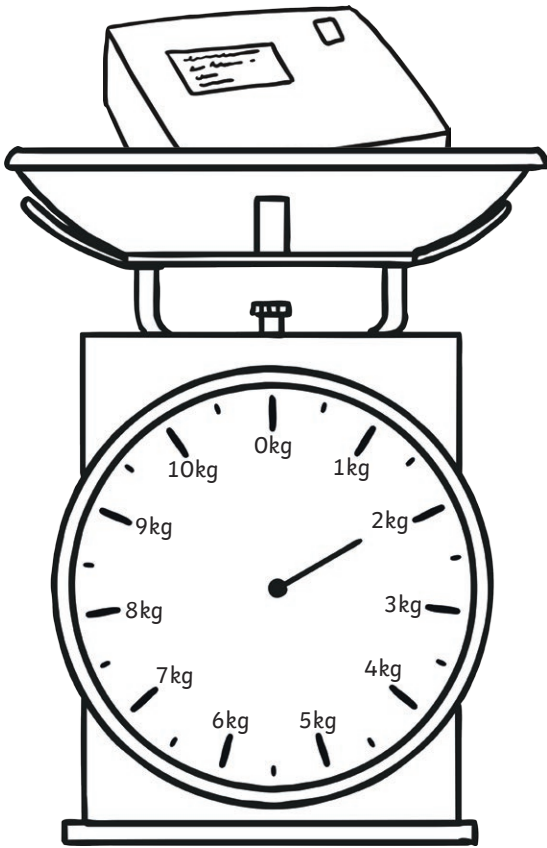

Reading Scales

Answers

Write the temperature shown on each thermometer.

15°C

20°C

5°C

8°C

Write how much liquid is in each jug.

7ml

14ml

8ml

2ml

Write how much each parcel weighs.

3kg

1kg

2kg

$1\frac{1}{2}$ kg

Reading Scales

Write the temperature shown on each thermometer.

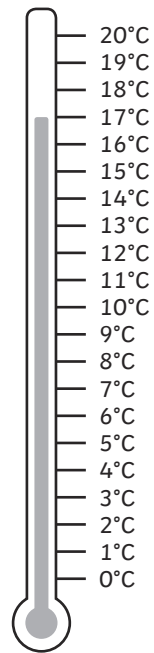
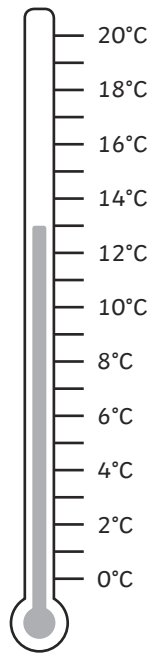
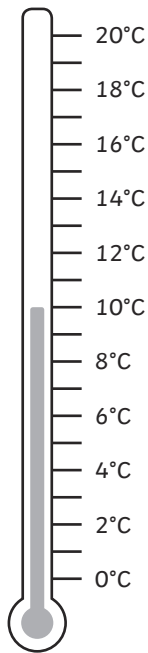
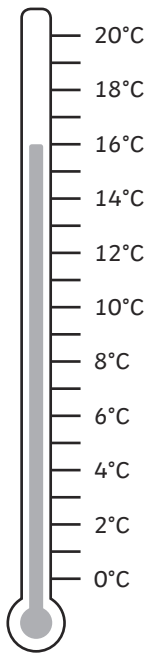

Write how much liquid is in each jug.

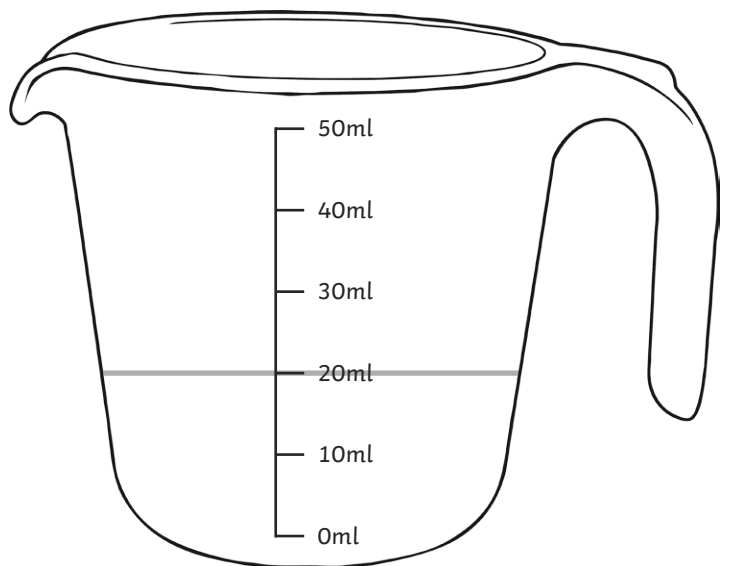
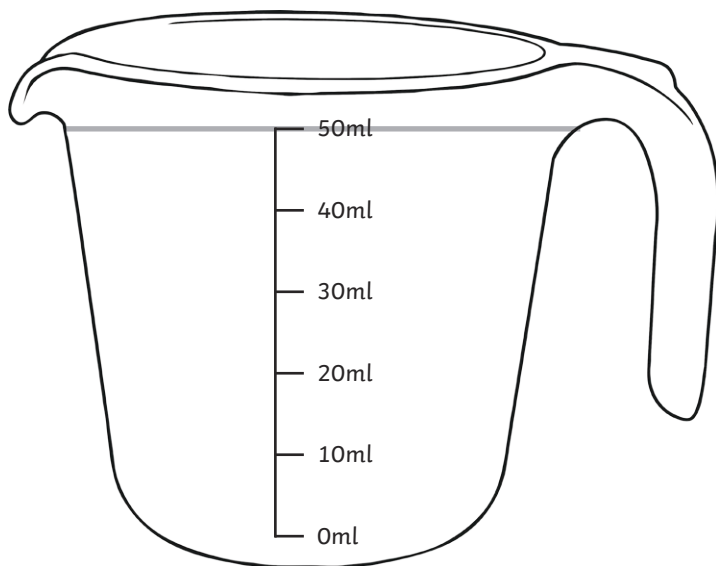

Reading Scales

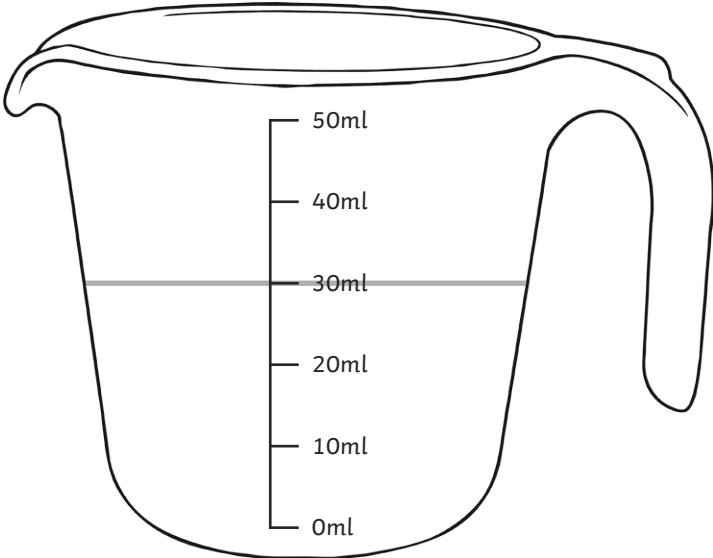

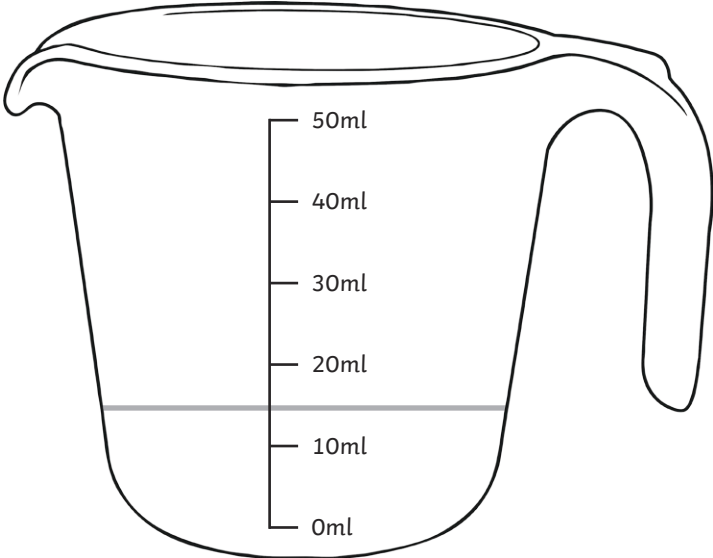

Write how much each parcel weighs.

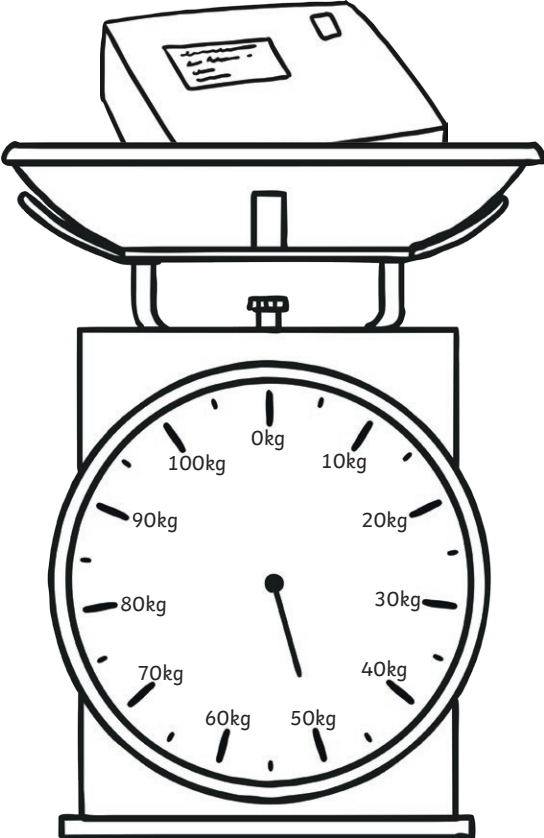

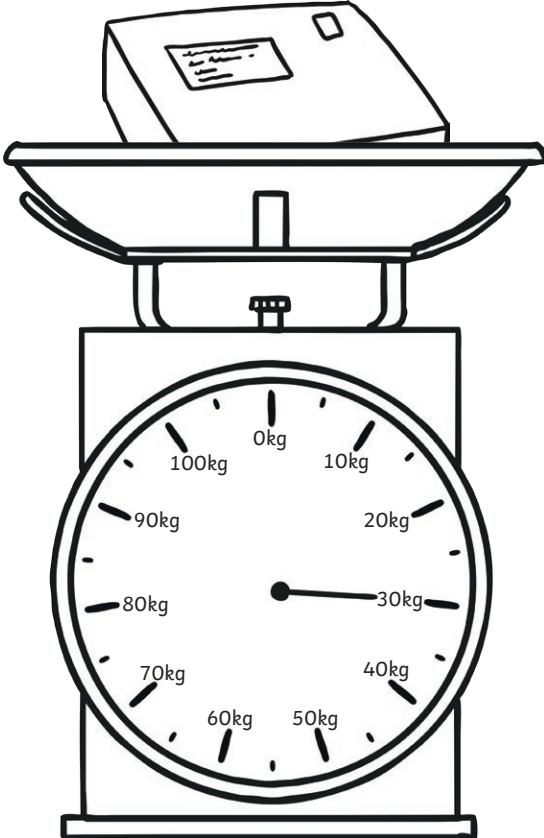

Reading Scales

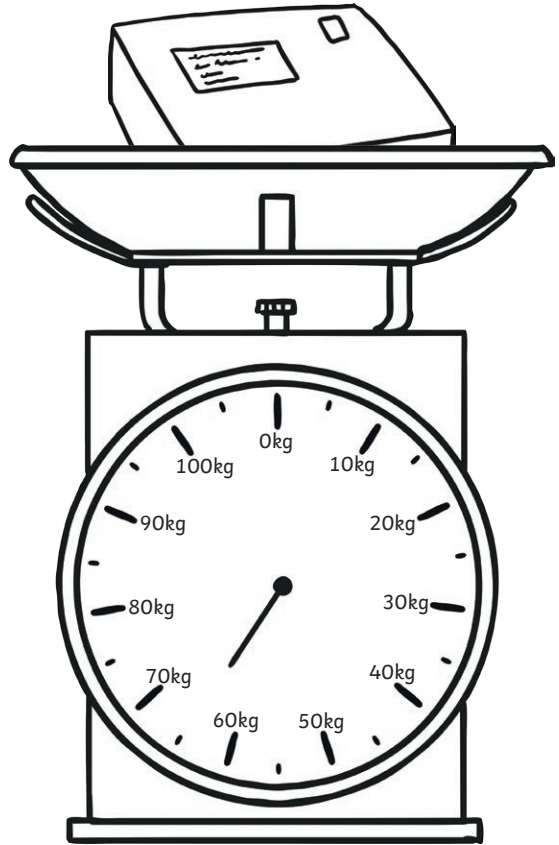
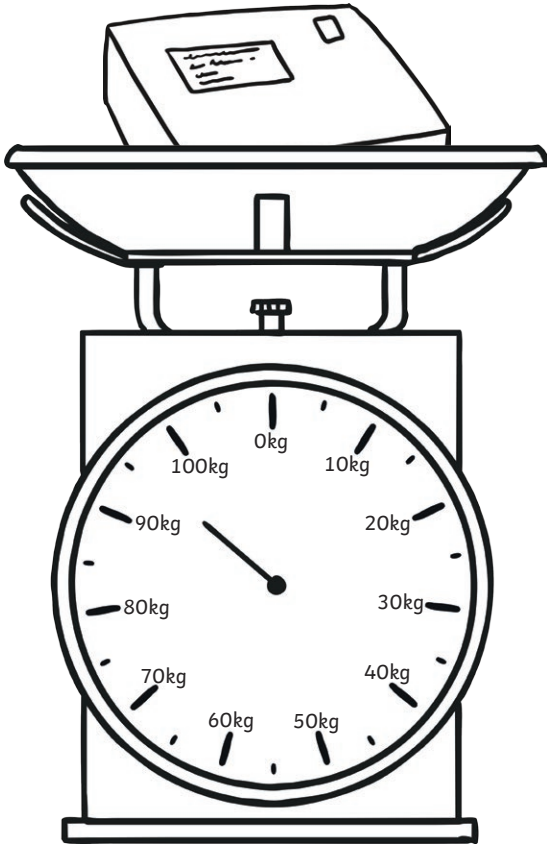

Reading Scales

Answers

Write the temperature shown on each thermometer.

16°C

10°C

13°C

17°C

Write how much liquid is in each jug.

50ml

20ml

30ml

15ml

Write how much each parcel weighs.

50kg

30kg

95kg

65kg

Reading Scales

Write the temperature shown on each thermometer.

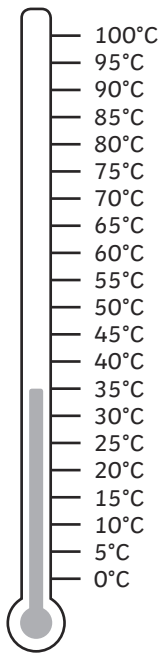

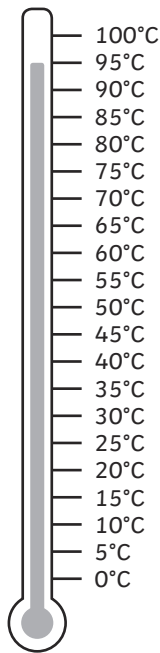

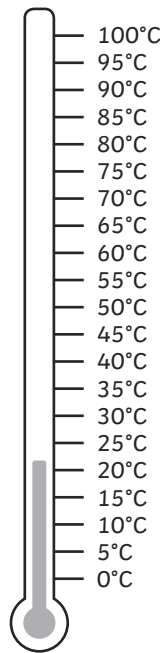

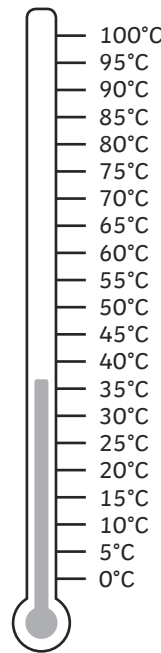

Write how much liquid is in each jug.

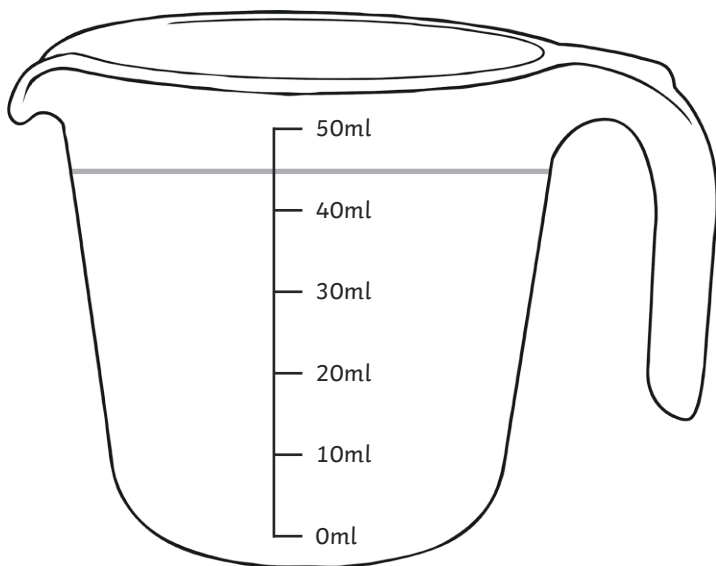

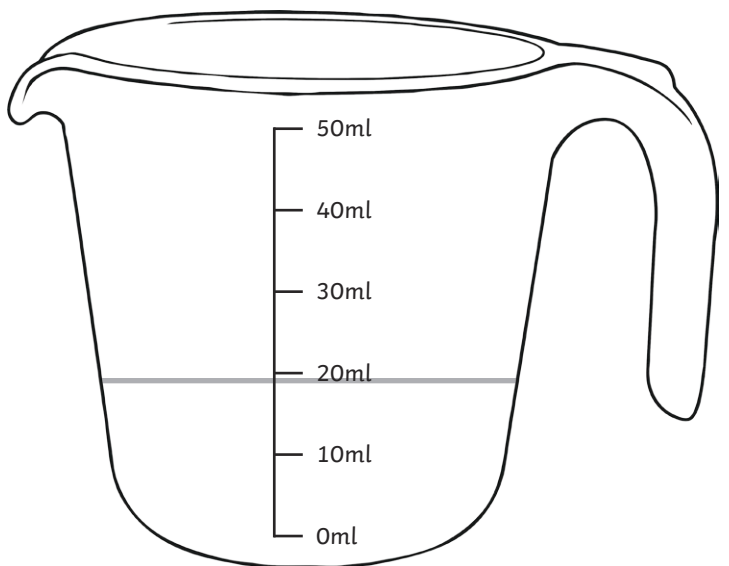

Reading Scales

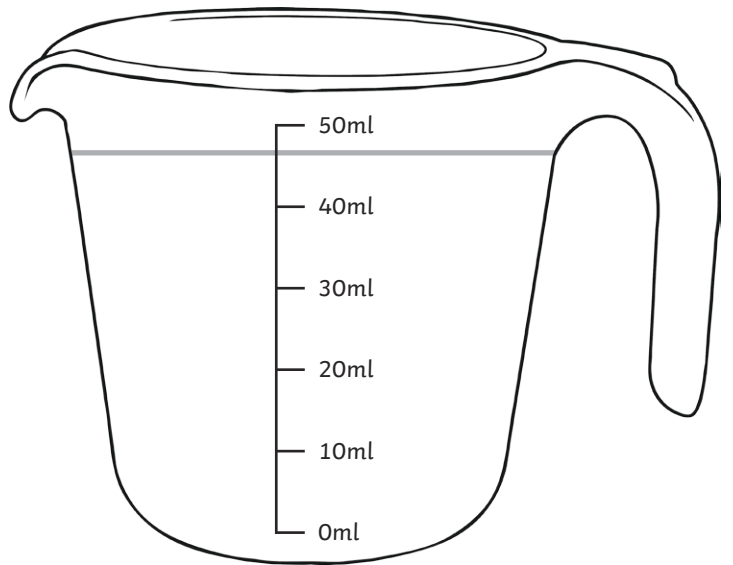
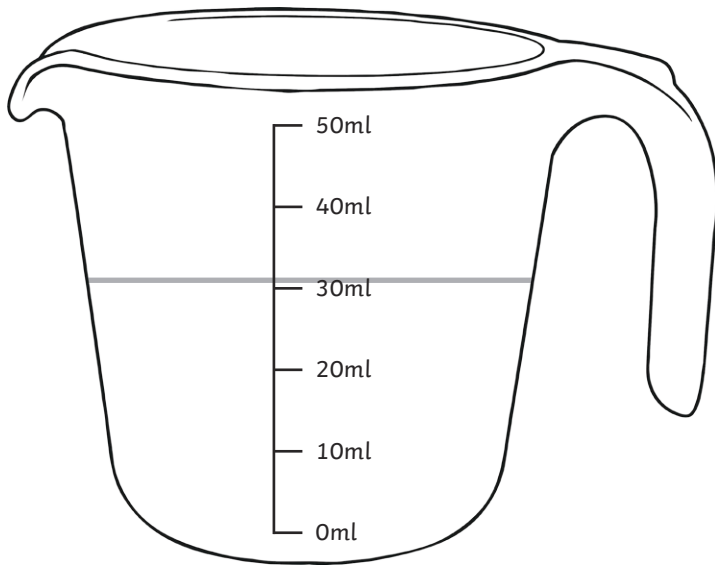

Write how much each parcel weighs.

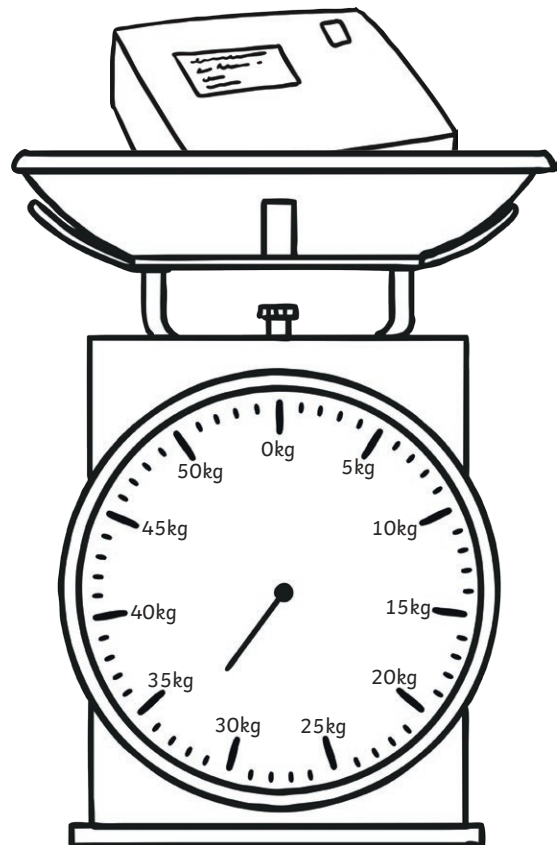
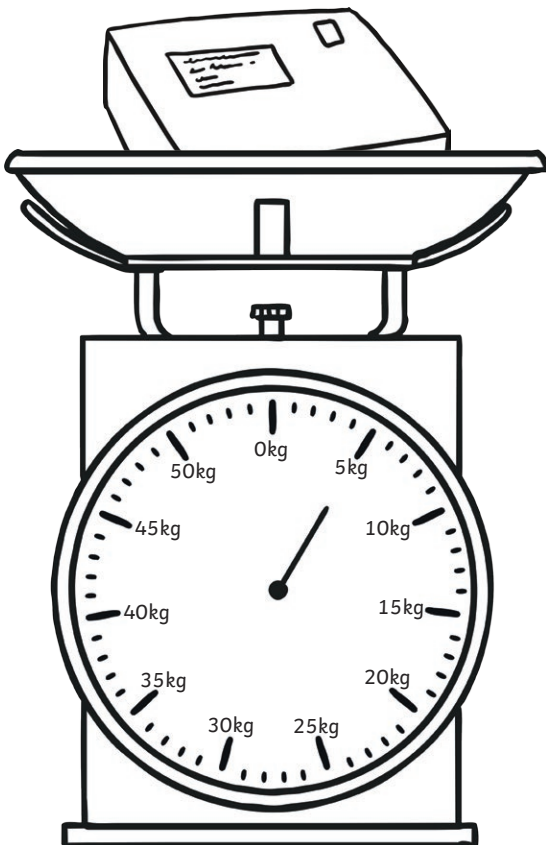

Reading Scales

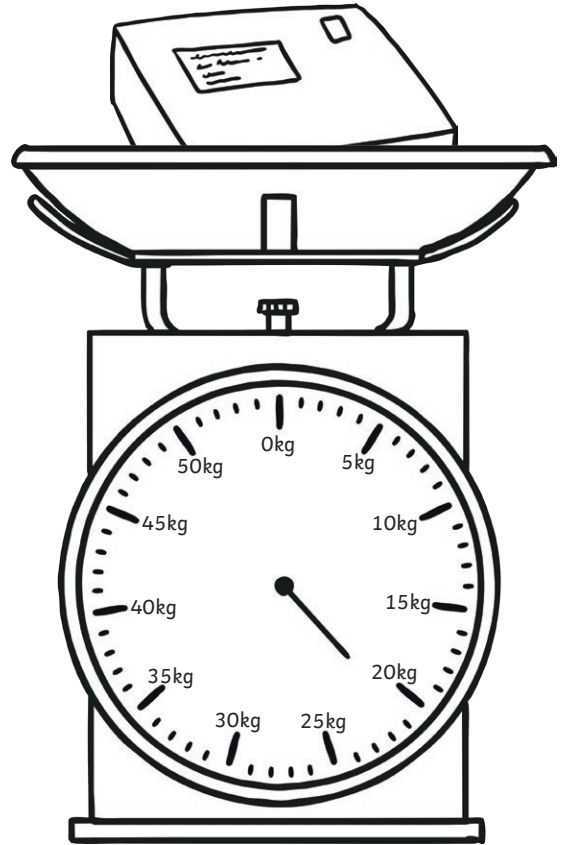
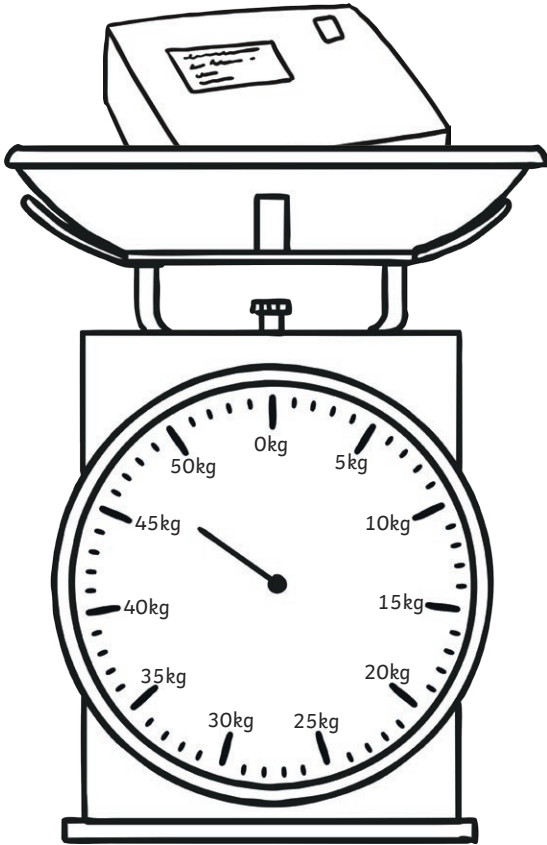

Reading Scales

Answers

Write the temperature shown on each thermometer.

35°C

95°C

22-23°C

37-38°C

Write how much liquid is in each jug.

45ml

18-19ml

31-32ml

47-48ml

Write how much each parcel weighs.

5kg

32-33kg

47-48kg

21-22kg